

Una



Table \

Convenient and functional table, ideal for common areas, office spaces or resident rooms. Wheelchair-accessible thanks to its overall height of 76 cm (74 cm clearance).

Wide choice of HPL colours for the table top and different epoxy colours for the metal base.

What makes the table Una so unique? \

- \ Sturdy steel frame
- \ Large range of sizes
- \ High clearance thanks to recessed rails

Subject to change without notice, latest update 202603v1, all images shown are for illustration purposes only

FRAME & LEGS

Steel frame and legs with recessed, hidden rails on four sides. The rails are fitted with mounting plates. Epoxy-coated with RAL colour according to colour collection. Fitted with plastic caps with adjustable feet, black PA.

TABLETOP

Tabletop type Laminated chipboard

Tabletop thickness 20 mm

Tabletop structure HPL top surface. Chipboard core with white cover layer underneath. Matching edging in rounded ABS.

Corners 4 square corners with 2 mm radius





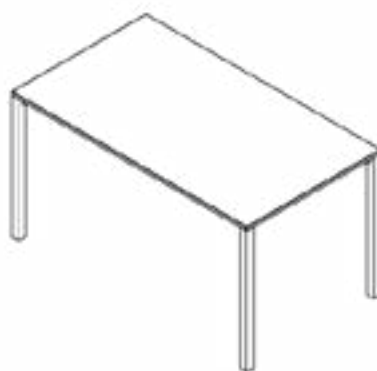

TABLE CONSTRUCTION

The table top is attached to the frame with screws. The frame is fitted with several mounting plates, each with 2 holes, so the screws clamp the table top to the frame.



Subject to change without notice, latest update 202603v1, all images shown are for illustration purposes only

DIMENSIONS

TYPE							
Una	60	80	76	74	17	yes	★ ★ ★
	80	80	76	74	19	yes	★ ★ ★
	90	90	76	74	23	yes	★ ★ ★
	140	80	76	74	29	yes	★ ★ ★
	160	80	76	74	32	yes	★ ★ ★
	160	90	76	74	35	yes	★ ★ ★
	180	90	76	74	38	yes	★ ★ ★
	200	90	76	74	42	yes	★ ★ ★
	220	90	76	74	45	yes	★ ★ ★
	250	90	76	74	50	yes	★ ★ ★

★ = domestic use / ★ ★ = project-based use / ★ ★ ★ = intensive project-based use
Standard dimensions; custom dimensions possible upon request

Subject to change without notice, latest update 202603v1, all images shown are for illustration purposes only