

Vento



Reclining armchair \

Designer armchair - an eye-catcher in every interior! Ideal for home use. The high-quality finish ensures a superb level of comfort. The perfect armchair to rest, watch TV or read a good book. The back with the standard manual headrest adjustment adds that little bit of extra comfort when sitting or lying. The armrests make it easier to stand up.

What makes the reclining armchair Vento so unique? \

- \ Choice between 3 reclining mechanisms
- \ 3 seat heights
- \ Manually adjustable headrest
- \ Fully upholstered

Subject to changes, most recently updated on 202603v1, all images are for illustration purposes only

RECLINING MECHANISMS



EL1

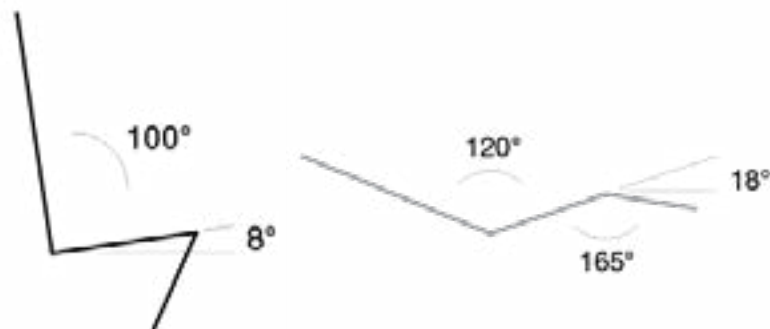

Electrically adjustable, with manual headrest adjustment as standard, with fold-out leg rest, back and leg adjustable in one single motion, back and seat with variable inclination angle, 1 motor.

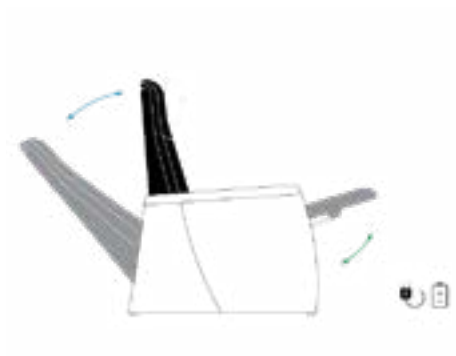

EL2

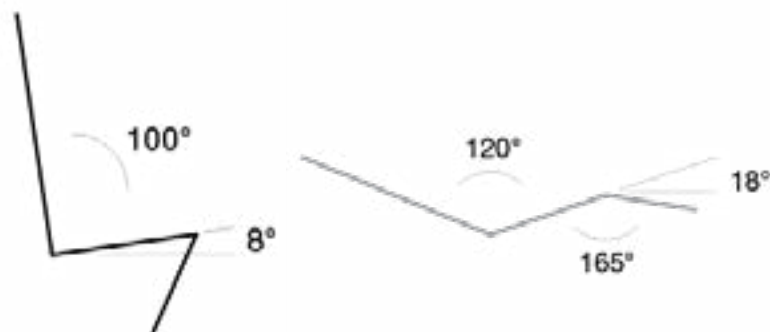

Electrically adjustable, with manual headrest adjustment as standard, with fold-out leg rest, back and leg individually adjustable, back and seat with variable inclination angle, 2 motors.

RECLINING MECHANISMS

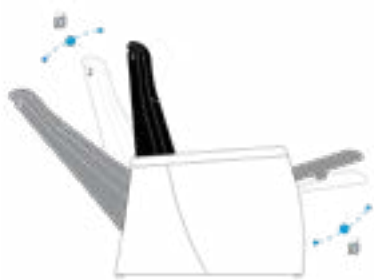

VE

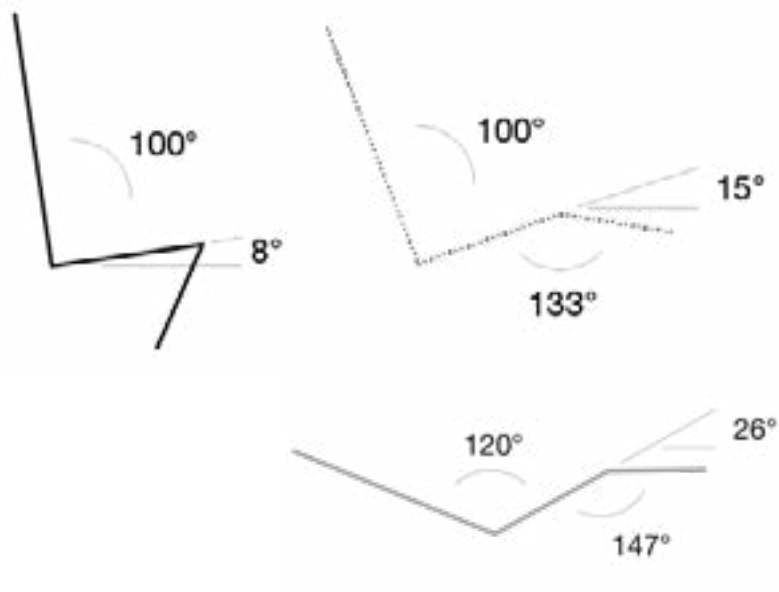

Manually adjustable, with manual headrest adjustment as standard, with fold-out leg rest, back and seat with variable inclination angle.

Subject to changes, most recently updated on 202603v1, all images are for illustration purposes only

TECHNICAL FEATURES

Frame Solid steel frame.











Back, seat, side panels and leg rest Upholstered. Back with webbing and seat with NOSAG springs. Back with manual headrest adjustment as standard (not in combination with castors).

Legs RVS stainless steel legs

OPTIONS & ACCESSORIES

- \\ Seat height 46, 48 or 50 cm
- \\ Castors Ø 75 mm (2 with brake)
- \\ Electric control in the right side panel (on the right when sitting down)

DIMENSIONS

TYPE											
Vento 1-seater	75	92	115	48-52	52	46/48/50	80	62/64/66	46-65	-	★ ★

★ = domestic use / ★ ★ = project-based use / ★ ★ ★ = intensive project-based use

Subject to changes, most recently updated on 202603v1, all images are for illustration purposes only