

Jeff

PEDRALI[®]

JEFF001 - JEFF002 - JEFF003 - JEFF004 - JEFF005 - JEFF006 - JEFF007 -
JEFF008 - JEFF009 - JEFF010

100%
MADE IN
ITALY

DESIGN
Patrick Norguet



EN: Modular sofa system with seat, backrest and armrest in polyurethane foam. They rest on a plywood platform covered in fabric and raised 3 cm of the ground

IT: Sistema di divani modulare con seduta, schienale e braccioli in schiumato poliuretano appoggiati su una piattaforma in multistrato sollevata da terra da piedini 3 cm e rivestito in tessuto

DE: Modulares Sofasystem mit Sitz, Rückenlehne und Armlehne aus Polyurethanschäum. Sie ruhen auf einer Sperrholzplattform, die mit Stoff überzogen ist und 3 cm über dem Boden liegt

FR: Système de canapé modulaire avec assise, dossier et accoudoir en mousse de polyuréthane. Ils reposent sur une plate-forme en contreplaqué recouverte de tissu et surélevée de 3 cm par rapport au sol

ES: Sistema de sofá modular con asiento, respaldo y reposabrazos de espuma de poliuretano. Descansan sobre una plataforma de madera contrachapada recubierta de tela y elevada 3 cm del suelo

mm - in

• JEFF001

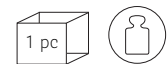
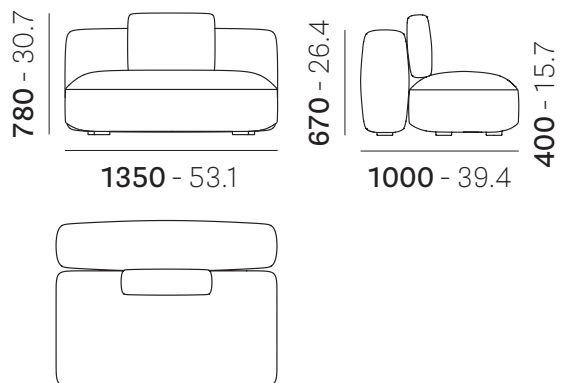

Disassembled mc 0,91 54,5 kg
Da assemblare ft³ 32.1 lb 120.6

• JEFF002

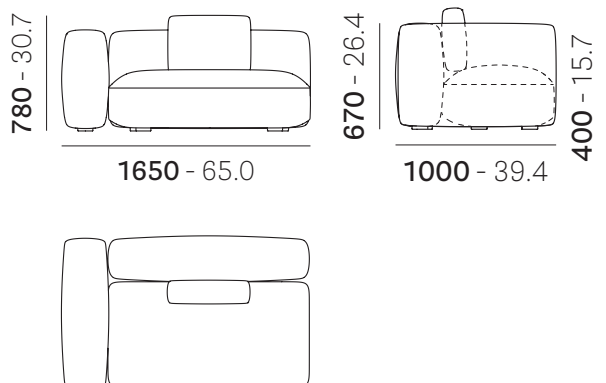

Disassembled mc 1,15 64,5 kg

Sous réserve de modifications, dernière mise à jour 2022-11, les images ne sont présentées qu'à des fins d'illustration

Jeff

PEDRALI[®]

JEFF001 - JEFF002 - JEFF003 - JEFF004 - JEFF005 - JEFF006 - JEFF007 -
JEFF008 - JEFF009 - JEFF010

DESIGN
Patrick Norguet

• JEFF003

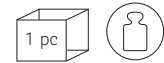
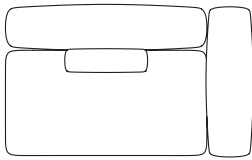
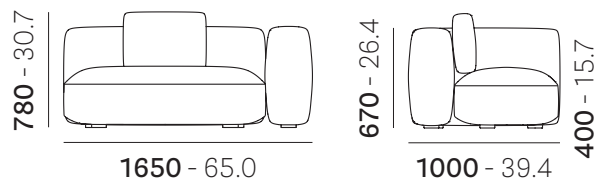

Disassembled **mc 1,15** **64,5 kg**
Da assemblare ft³ 40.6 lb 142.2

• JEFF004

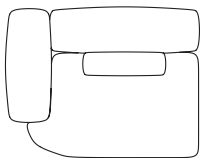
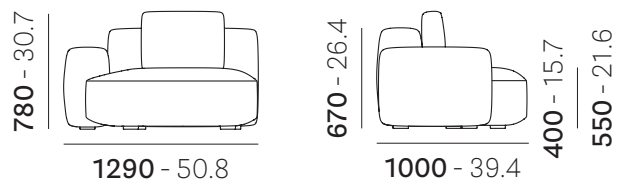

Disassembled **mc 0,95** **52,5 kg**
Da assemblare ft³ 33,5 lb 13.6

• JEFF005

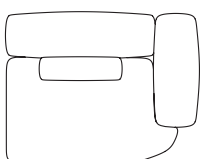
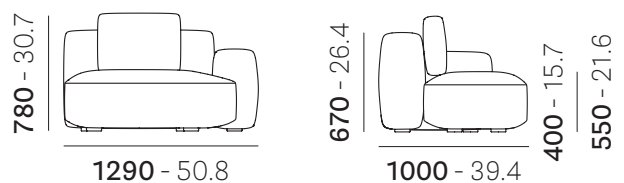

Disassembled **mc 0.95** **52,5 kg**

Sous réserve de modifications, dernière mise à jour 2022-11, les images ne sont présentées qu'à des fins d'illustration

Jeff

PEDRALI[®]

JEFF001 - JEFF002 - JEFF003 - JEFF004 - JEFF005 - JEFF006 - JEFF007 -
JEFF008 - JEFF009 - JEFF010

DESIGN
Patrick Norguet

• JEFF006

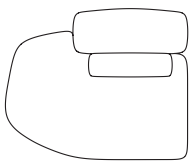
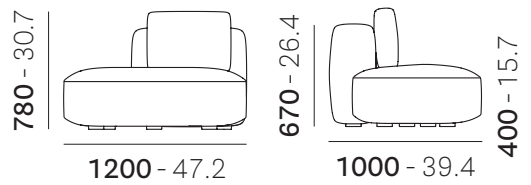

Disassembled
Da assemblare

mc 0,77
ft³ 27.1

42 kg
lb 92.5

• JEFF007

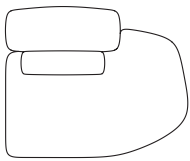
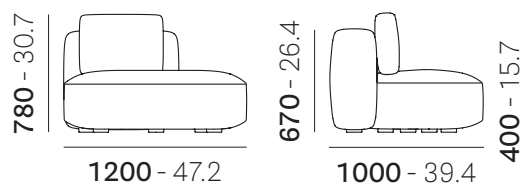

Disassembled
Da assemblare

mc 0,77
ft³ 27.1

42 kg
lb 92.5

• JEFF008

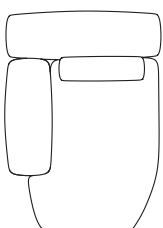
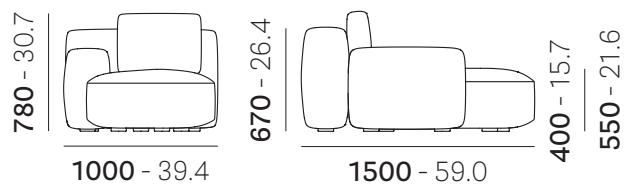

Disassembled

mc 0,99

68 kg

Sous réserve de modifications, dernière mise à jour 2022-11, les images ne sont présentées qu'à des fins d'illustration

Jeff

PEDRALI[®]

JEFF001 - JEFF002 - JEFF003 - JEFF004 - JEFF005 - JEFF006 - JEFF007 -
JEFF008 - JEFF009 - JEFF010

DESIGN
Patrick Norguet

• JEFF009

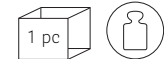
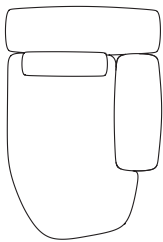
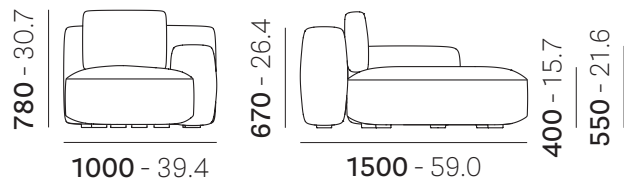

Disassembled mc 0,99 68 kg
Da assemblare ft³ 34.6 lb 149

• JEFF010

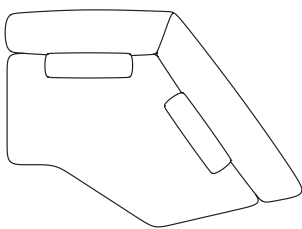
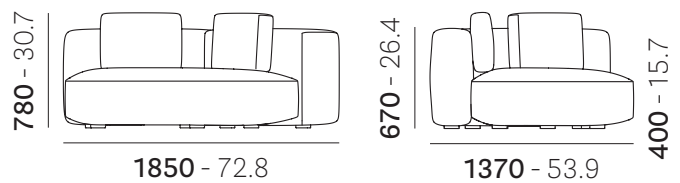

Disassembled mc 1,67 80 kg
Da assemblare ft³ 59.9 lb 176

Sous réserve de modifications, dernière mise à jour 2022-11, les images ne sont présentées qu'à des fins d'illustration

JEFF001 - JEFF002 - JEFF003 - JEFF004- JEFF005 - JEFF006 - JEFF007 -
JEFF008 - JEFF009 - JEFF010

DESIGN
Patrick Norguet

<p>MATERIALS</p> <p>Materiali Materialien Matériaux Materiales</p>	<ul style="list-style-type: none"> • SEAT - SEDUTA - SITZ - ASSISE - ASIENTO EN: Seat upholstered with flexible polyurethane foam of different densities fire retardant (class 1 IM), and covered in fabric IT: Seduta imbottita con poliuretano espanso flessibile di diverse densità ignifugo (classe 1 IM), e rivestito in tessuto DE: Sitz gepolstert mit flexiblem Polyurethanschaum unterschiedlicher Dichte feuerhemmend (Klasse 1 IM), und mit Stoff bezogen FR: Assise garnie de mousse de polyuréthane flexible de différentes densités ignifuge (classe 1 IM), et recouverte de tissu ES: Asiento tapizado con espuma de poliuretano flexible de diferentes densidades ignifugo (clase 1 IM), y recubierto de tela • BACKREST - SCHIENALE - RÜCKENLEHNE - DOSSIER - RESPALDO EN: Backrest with multilayer internal structure, padded with flexible polyurethane foam, fire retardant (class 1 IM) and covered in fabric IT: Schienale con struttura interna in multistrato, imbottito con poliuretano espanso flessibile ignifugo (classe 1 IM) e rivestito in tessuto DE: Rückenlehne mit mehrschichtiger Innenstruktur, gepolstert mit flexiblem Polyurethanschaum feuerfest (Klasse 1 IM) und mit Stoff bezogen FR: Dossier avec structure interne multicouche, rembourré de mousse de polyuréthane souple ignifugé (classe 1 IM) et recouvert de tissu ES: Respaldo con estructura interna multicapa, acolchado con espuma de poliuretano flexible ignifugo (clase 1 IM) y recubierto de tela • ARMREST - BRACCIOLO - ARMLEHNENPOLSTER - ACCOUDOIR - REPOSABRAZOS EN: Armrest with plywood internal structure padded with flexible polyurethane foam fire retardant (class 1) covered in fabric IT: Bracciolo con struttura interna in multistrato imbottito con poliuretano espanso flessibile ignifugo (classe 1) rivestito in tessuto DE: Armlehne mit mehrschichtiger Innenstruktur, gepolstert mit flexiblem Polyurethanschaum feuerhemmend (Klasse 1) und mit Stoff bezogen FR: Accoudoir avec structure interne multicouche rembourré de mousse de polyuréthane flexible ignifuge (classe 1) recouvert de tissu ES: Apoyabrazos con estructura interna multicapa acolchada con espuma de poliuretano flexible ignifuga (clase 1) cubierta de tela <p>FABRIC - TESSUTO - STOFF - TISSU - TEJIDO</p> <p>Cat. D120÷D123 - H140÷H143- G120÷G122</p> <p>EN: For more information see finishing legend on the website IT: Per maggiori informazioni vedere legenda finiture sul sito web</p>
<p>ACCESSORIES</p> <p>Accessori Zubehör Accessoires Accesorios</p>	<p>Code: 3012</p> <p>EN: Cushion Ø440mm IT: Cuscino Ø440mm DE: Kissen Ø440mm FR: Coussin Ø440mm ES: Cojín Ø440mm</p> <p>Code: 3013</p> <p>EN: Cushion 450xh300mm IT: Cuscino 450xh300mm DE: Kissen 450xh300mm FR: Coussin 450xh300mm ES: Cojín 450xh300mm</p>

Sous réserve de modifications, dernière mise à jour 2022-11, les images ne sont présentées qu'à des fins d'illustration

JEFF001 - JEFF002 - JEFF003 - JEFF004- JEFF005 - JEFF006 - JEFF007 -
JEFF008 - JEFF009 - JEFF010

DESIGN
Patrick Norguet

MATERIALS

Materiali
Materialien
Matériaux
Materiales

• ENVIRONMENTAL IMPACT - IMPATTO AMBIENTALE - UMWELTBELASTUNG - IMPACT SUR L'ENVIRONNEMENT - IMPACTO AMBIENTAL

MATERIAL Materiale	WEIGHT (Kg) Peso (Kg)	% TOTAL ITEM % totale articolo	MATERIAL RECYCLABILITY Riciclabilità' del materiale	% RECYCLED AT ORIGIN % riciclato all'origine	% RECYCLABLE END OF PRODUCT LIFE % riciclabile fine vita prodotto
Steel Acciaio	2,7	41,8	YES	33,2	100
Polypropylene Polipropilene	0,2	0,4	YES	0	100
Technopolymer Tecnopolimero	1,2	2,8	YES	40	100
Polyurethane foam Poliuretano espanso	13	30,5	NO	0	0
Plywood Multistrato	23,6	56,1	YES	0	100
Fabric Tessuto	1,37	3,2	NO	0	0
TOTAL TOTALE	42,15 Kg	--	--	3,3 %	65,9 %

EN: Percentages referred to JEFF006
IT: Percentuali riferite al JEFF006

• COMPANY CERTIFICATIONS - CERTIFICAZIONI AZIENDALI - UNTERNEHMENSZERTIFIZIERUNGEN - CERTIFICACIONES D'ENTREPRISE - CERTIFICACIONES DE LA EMPRESA

ISO 14001
Environmental management system
Sistema di gestione ambientale

ISO 9001
Quality management system
Sistema di gestione della qualità



Sous réserve de modifications, dernière mise à jour 2022-11, les images ne sont présentées qu'à des fins d'illustration